



FA-1 series

Spin-on filters



Technical Information

Housing

Pressure: Max working 12 bar (175 psi) (acc. to NFPA T 3.10.17)
Burst 20 bar (290 psi) (acc. to NFPA T 3.10.17)

Connection Ports: 3/4" ÷ 1 1/2" BSP (other thread options on request)

Materials: Head: aluminium alloy
Bowl: steel
Seal: Buna-N

By-pass: Suction line 0,25 bar (3.6 psi) setting
Return line 1,7 bar (24.6 psi) setting

Element

Filter Media: Microglass fiber 4,5 - 7 - 12 - 27 $\mu\text{m}_{(c)}$ (acc. to ISO 16889)
Cellulose 10 - 25 $\mu\text{m}_{(c)}$ (acc. to ISO 16889)
Wire mesh 60 - 125 μm

Differential collapse pressure: 4 bar (58 psi) (acc. to ISO 2941)

Filtrec elements are tested also according to ISO 2942, ISO 23181 and ISO 3968

Common

Working temperature: -25°C +120°C (-13°F +248°F)

Fluid compatibility (acc. to ISO 2943):

Full with HH-HL-HM-HV (acc. to ISO 6743/4).

For use with other fluid applications please contact Filtrec Customer Service (info@filtrec.it).

Ordering information



SUCTION (n.b. for return & inline see page 6)
LINE

MEDIA	
000	no element
C10	cellulose $\beta_{10 \mu\text{m (c)}} \geq 2$
C25	cellulose $\beta_{25 \mu\text{m (c)}} \geq 2$
G10	microglass fiber $\beta_{12 \mu\text{m (c)}} \geq 1000$
G25	microglass fiber $\beta_{27 \mu\text{m (c)}} \geq 1000$
T60	wire mesh 60 μm
T125	wire mesh 125 μm

	NOMINAL SIZE	MEDIA	SEALS	CONNECTION	BY-PASS	INDICATOR
Filter assembly FA-1	31	C10	B	B7	S	S1

Filter element A1	21	C10				
------------------------------------	-----------	------------	--	--	--	--

ELEMENT

FA-1-1x	A1-1x (1 pc.)
FA-1-2x	A1-2x (1 pc.)
FA-1-3x	A1-2x (2 pc.)
FA-1-4x	A1-2x (2 pc.)

SEALS

B	NBR
----------	-----

CONNECTION

B4	3/4" BSP (size 10-11)
B6	1 1/4" BSP (size 20-21)
B7	1 1/2" BSP (size 30-41)

For different thread options please check availability with Filtrac Customer Service.

BY-PASS

0	no by-pass
S	0,25 bar / 3,6 psi

Preferential option

INDICATOR

00	no indicator
R7	pressure/vacuum gauge -1 ÷ 5 bar / -14,5 ÷ 72,5 psi
S1	vacuum gauge indicator scale 0 ÷ -1 bar / 0 ÷ -14,5 psi
S4	visual vacuum switch -0,2 bar / -2,9 psi
S13	vacuum switch -0,2 bar / -2,9 psi SPDT

Overall dimensions

FA-1-10/11

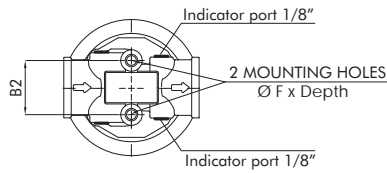
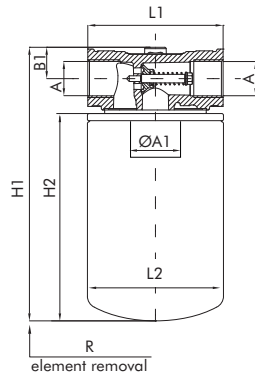

FA-1-20/21

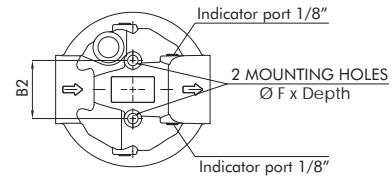
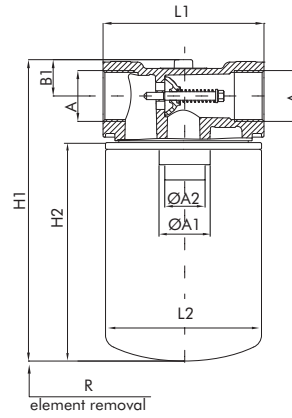

FA-1-30/31

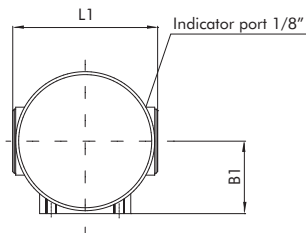
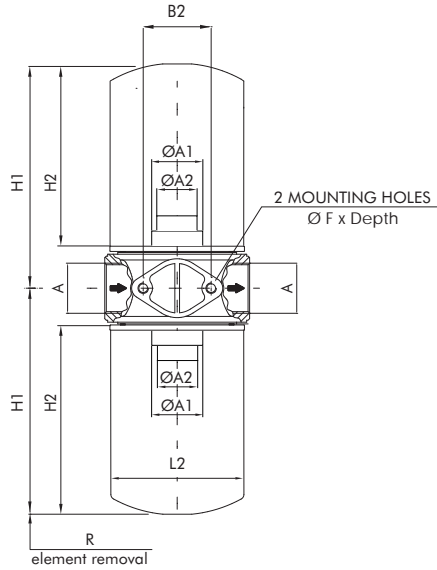

FA-1-40/41

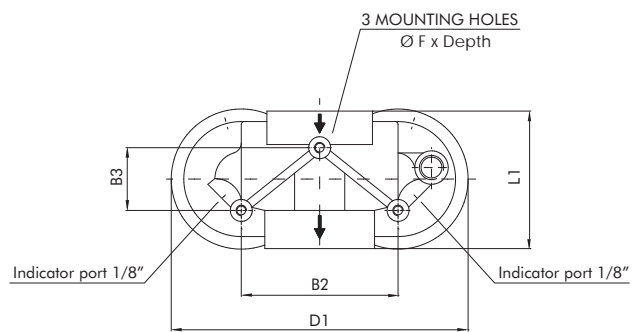
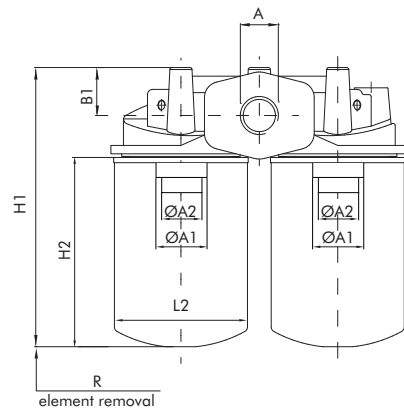

Nominal size

CODE	A	A1	A2	B1	B2	B3	D1	F	H1	L1	R	WEIGHT	ELEMENT	H2	L2
FA-1-10	3/4"	3/4"	---	22	38			M8x15	192	95	20	1,3 Kg	A-1-10	148	96
FA-1-11	BSP	BSP					257							1,5 Kg	A-1-11
FA-1-20	1 1/4"	1 1/4"	1 1/2"	30	50	---	---		249	133	40	1,9 Kg	A-1-20	182	128
FA-1-21	BSP	BSP	16-UN						295					2,2 Kg	A-1-21
FA-1-30	1 1/2"			70	65			M10x15	218	140	40	3,6 Kg	2x A-1-20		
FA-1-31	BSP								262					3,8 Kg	2x A-1-21
FA-1-40	1 1/2"			46	150	60	284		267	132	40	5,0 Kg	2x A-1-20		
FA-1-41	BSP								313					5,2 Kg	2x A-1-21

For different thread options please contact Filtec Customer Service.

FA-1 series

Pressure drop diagrams

The total Pressure Drop (Δp) value is obtained by adding the Δp values of filter housing and filter element at the given flow rate. This ideally should not exceed 0,2 bar (2,9psi).

PRESSURE DROP THROUGH THE FILTER HOUSING

The Pressure Drop through the filter housing is governed by the port, not the bowl length and the oil viscosity.

PRESSURE DROP THROUGH THE CLEAN FILTER ELEMENT

The Pressure Drop through the filter element is related both to the internal diameter of the filter element and to the filter media; this value is affected by the oil viscosity in a roughly proportional way: e.g. when the Δp value from the curve is 0,1 bar and a 46 cSt oil is used, the corresponding value is 0,15 (=0,1 x 46/30) bar.

Element A-1-10-..

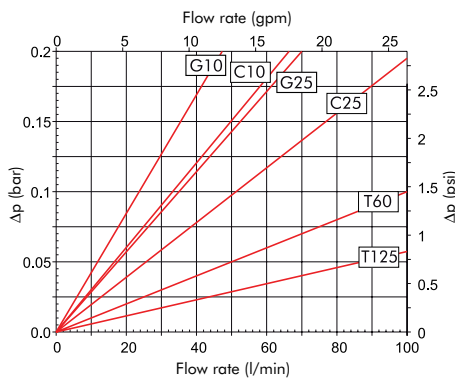

Element A-1-20-..

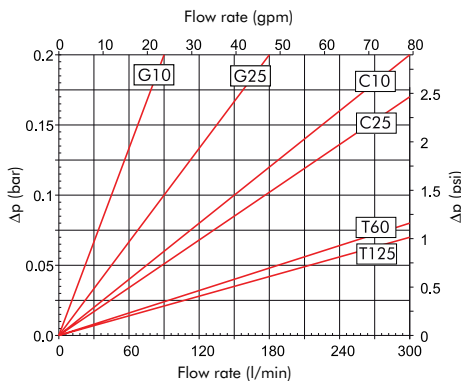

PRESSURE DROP THROUGH THE BY-PASS VALVE

The by-pass valve is a safety device to prevent element collapse in case of differential pressure peaks due to flow peaks, cold start conditions or when the clogged element is not replaced in a timely manner.

Housing

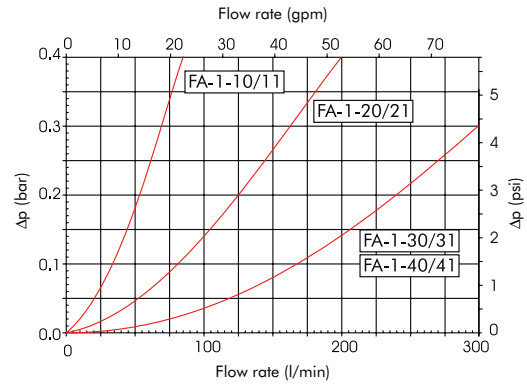

Element A-1-11-..

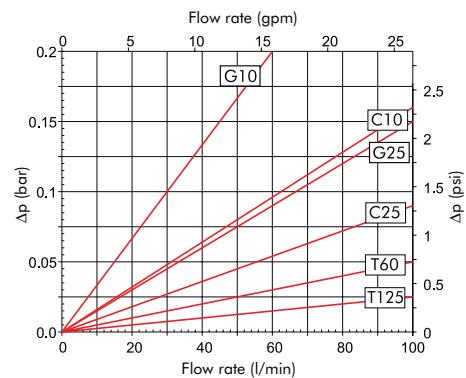

Element A-1-21-..

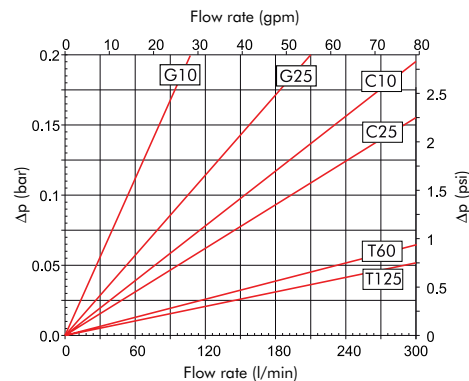

By-pass

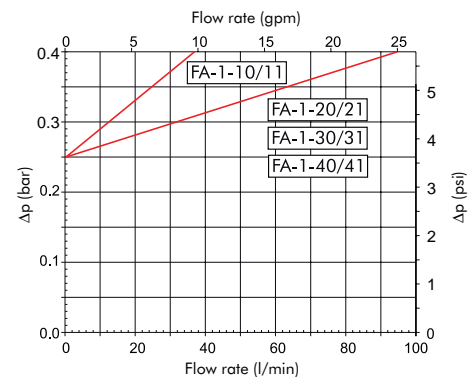

The above diagrams have been obtained at the FILTREC laboratory, according to the ISO 3968 specification, with mineral oil having 30 cSt viscosity and 0,86 Kg/dm³ density.

In case of discrepancy, please check contamination level, viscosity and features of the oil in use and the sampling points of the differential pressure.

Clogging indicator

The Pressure Drop (Δp) through the filter increases during the system operation due to the contaminant retained by the filter element.
The filter element must be replaced when the indicator shows an alarm and before the Δp reaches the by-pass value setting.

N.B. in cold start conditions a false alarm can be caused by higher oil viscosity due to low temperature; the indicator alarm must be considered at normal working temperature only.

PRESSURE/ VACUUM GAUGE

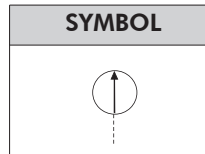
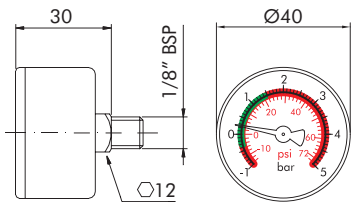

CODE	SCALE
R7	0 ÷ -0,2 bar (0 ÷ -2,9 psi) green sector
	-0,2 ÷ -1 bar (-2,9 ÷ -14,5 psi) red sector

Housing in black ABS material

Multipurpose product: this gauge can also be used as pressure gauge on return filters.

VACUUM GAUGE

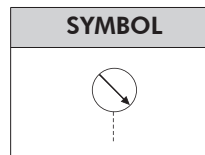
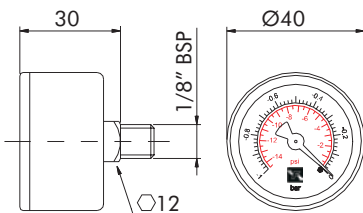

CODE	SCALE
S1	0 ÷ -1 bar (0 ÷ -14,5 psi)

Housing in black ABS material

VISUAL VACUUM SWITCH

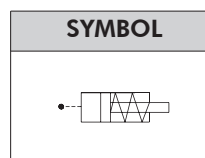
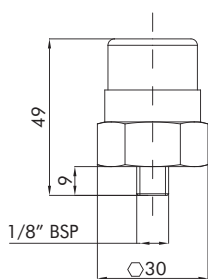

CODE	SETTING
S4	-0,2 bar (-2,9 psi)

 Preferential option

VACUUM SWITCH

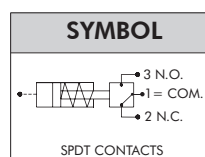
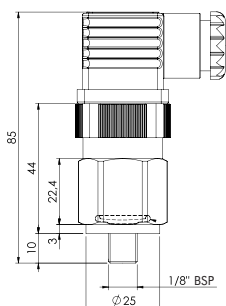

CODE	SETTING
S13	-0,2 bar (-2,9 psi) SPDT

- DC: 30 V – 4 A inductive, 3 A resistive
- AC: 250 V 3 A inductive, 2 A resistive
- Protection: IP65, connector DIN43650
- SPDT contacts

N.B. it can be used as N.O. contacts or N.C. contacts switch only, simply connecting 1 and 3 or 1 and 2 only, respectively.

Ordering information

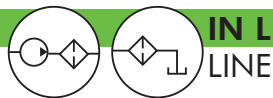

IN LINE / RETURN (n.b. for suction see page 2)

MEDIA	
000	no element
G03	microglass fiber $\beta_{4,5 \mu\text{m (c)}} \geq 1000$
G06	microglass fiber $\beta_{7 \mu\text{m (c)}} \geq 1000$
G10	microglass fiber $\beta_{12 \mu\text{m (c)}} \geq 1000$
G25	microglass fiber $\beta_{27 \mu\text{m (c)}} \geq 1000$
C10	cellulose $\beta_{10 \mu\text{m (c)}} \geq 2$
C25	cellulose $\beta_{25 \mu\text{m (c)}} \geq 2$

	NOMINAL SIZE	MEDIA	SEALS	CONNECTION	BY-PASS	INDICATOR
Filter assembly FA-1	31	C10	B	B7	R	R12
Filter element A1	21	C10				

ELEMENT	
FA-1-1x	A1-1x (1 pc.)
FA-1-2x	A1-2x (1 pc.)
FA-1-3x	A1-2x (2 pc.)
FA-1-4x	A1-2x (2 pc.)

SEALS	
B	NBR

CONNECTION	
B4	3/4" BSP (size 10-11)
B6	1 1/4" BSP (size 20-21)
B7	1 1/2" BSP (size 30-41)

For different thread options, please check availability with Filtrac Customer Service.

BY-PASS	
0	no by-pass
R	1,7 bar / 24,6 psi

	INDICATOR	Preferential option	Return	In line
00	no indicator			
R6	visual pressure switch 1,3 bar / 18,9 psi		■	
R7	pressure/vacuum gauge -1 ÷ 5 bar / -14,5 ÷ 72,5 psi		■	
R9	pressure gauge 0 ÷ 4 bar / 0 ÷ 58 psi	■		
R12	pressure gauge indicator scale 0 ÷ 16 bar / 0 ÷ 232 psi	■		■
R13	pressure switch 1,3 bar / 18,9 psi SPDT	■		
Z1	differential visual indicator 1,3 bar / 18,9 psi		■	■
Z2	differential electric visual indicator 1,3 bar / 18,9 psi		■	■
Z20	differential visual indicator 1,3 bar / 18,9 psi		■	■

For FA-1-3x only [Z1, Z2]

For FA-1-4x only [Z20]

Overall dimensions

FA-1-10/11

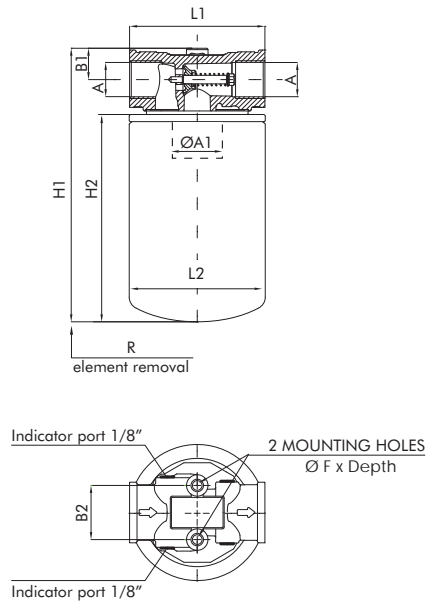

FA-1-20/21

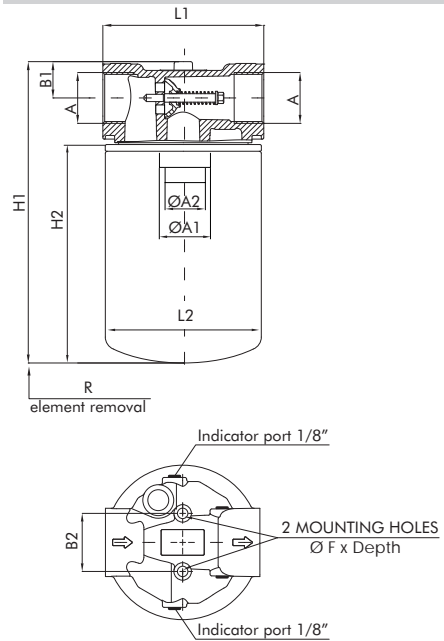

FA-1-30/31

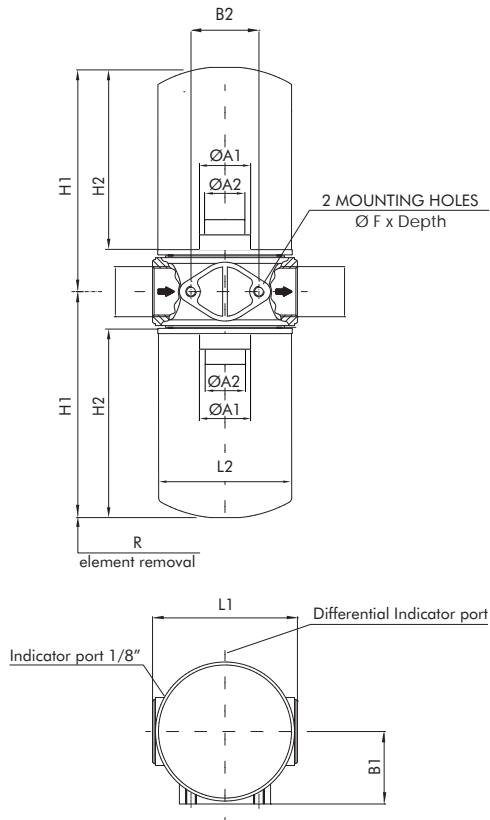

FA-1-40/41

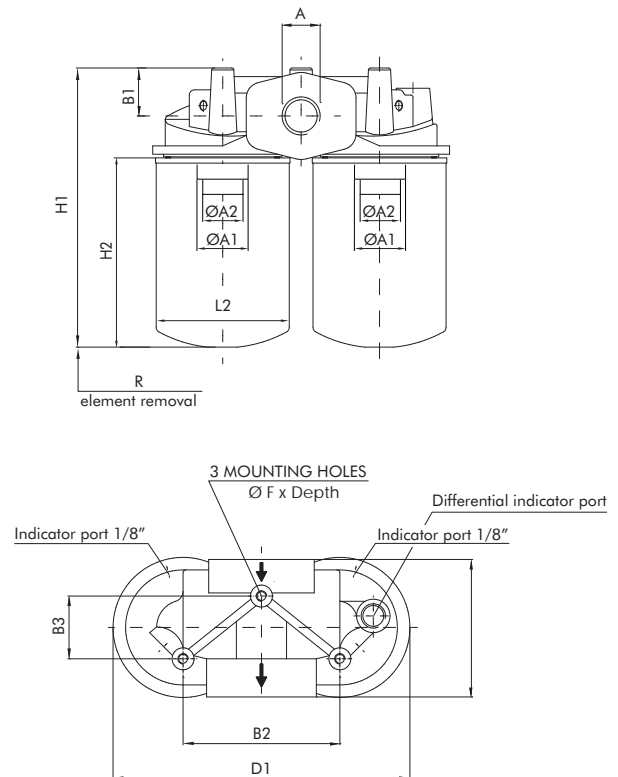

Nominal size

CODE	A	A1	A2	B1	B2	B3	D1	F	H1	L1	R	WEIGHT	ELEMENT	H2	L2
FA-1-10	3/4"	3/4"	---	22	38			M8x15	192	95	20	1,3 Kg	A-1-10	148	96
FA-1-11	BSP	BSP	---				257		1,5 Kg			A-1-11	213	96	
FA-1-20	1 1/4"	1 1/4"	1 1/2"	30	50	---	---		249	133		1,9 Kg	A-1-20	182	128
FA-1-21	BSP	BSP	16-UN						295			2,2 Kg	A-1-21	228	128
FA-1-30	1 1/2"			70	65			M10x15	218	140	40	3,6 Kg	2x A-1-20	---	
FA-1-31	BSP	---	---						262			3,8 Kg	2x A-1-21		
FA-1-40	1 1/2"			46	150	60	284		267	132		5,0 Kg	2x A-1-20		
FA-1-41	BSP								313			5,2 Kg	2x A-1-21		

For different thread options please contact Filtrac Customer Service.

FA-1 series

Pressure drop diagrams

The total Pressure Drop (Δp) value is obtained by adding the Δp values of filter housing and filter element at the given flow rate. This ideally should not exceed 0,5 bar (7,2psi).

PRESSURE DROP THROUGH THE FILTER HOUSING

The Pressure Drop through the filter housing is governed by the port, not the bowl length and the oil viscosity.

PRESSURE DROP THROUGH THE CLEAN FILTER ELEMENT

The Pressure Drop through the filter element is related both to the internal diameter of the filter element and to the filter media; this value is affected by the oil viscosity in a roughly proportional way: e.g. when the Δp value from the curve is 0,2 bar and a 46 cSt oil is used, the corresponding value is $0,31 (= 0,2 \times 46/30)$ bar.

Element A-1-10-..

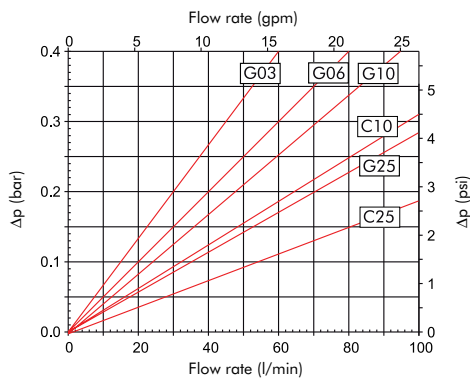

Element A-1-20-..

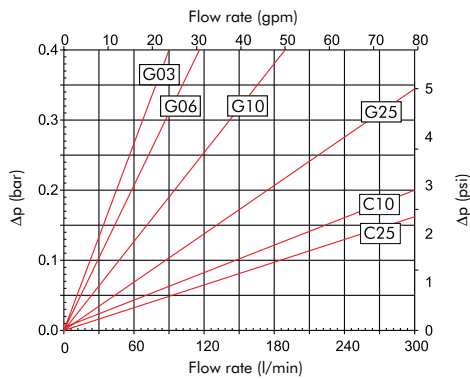

PRESSURE DROP THROUGH THE BY-PASS VALVE

The by-pass valve is a safety device to prevent element collapse in case of differential pressure peaks due to flow peaks, cold start conditions or when the clogged element is not replaced in a timely manner.

Housing

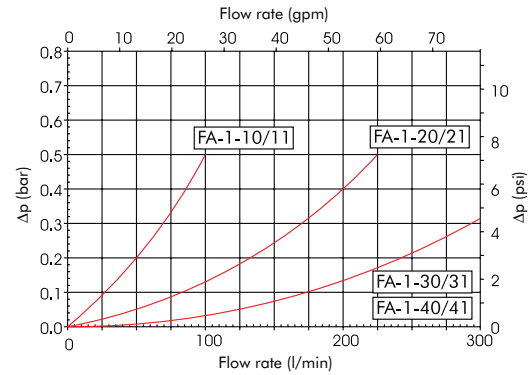

Element A-1-11-..

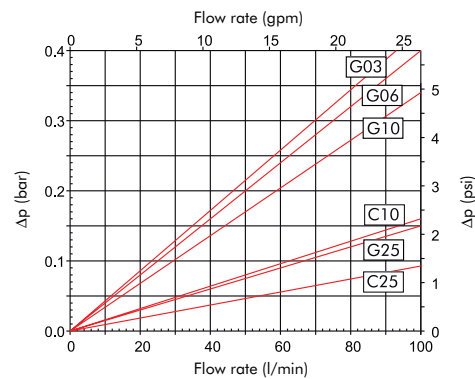

Element A-1-21-..

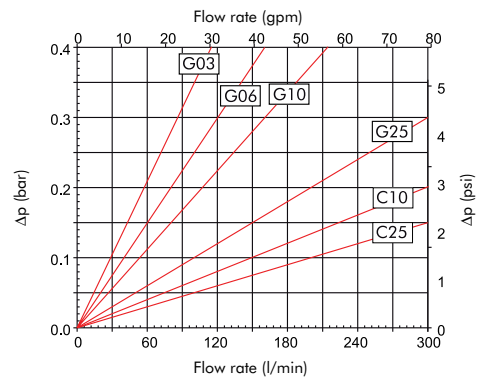

By-pass

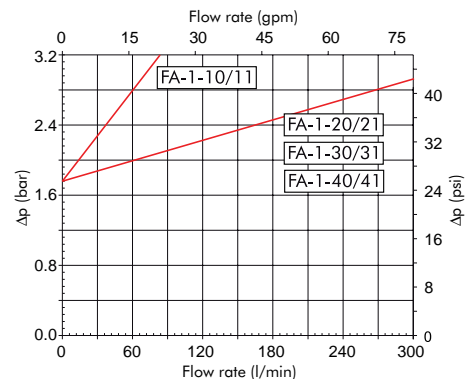

The above diagrams have been obtained at the FILTREC laboratory, according to the ISO 3968 specification, with mineral oil having 30 cSt viscosity and 0,86 Kg/dm³ density.

In case of discrepancy, please check contamination level, viscosity and features of the oil in use and the sampling points of the differential pressure.

Clogging indicator

The Pressure Drop (Δp) through the filter increases during the system operation due to the contaminant retained by the filter element.

The filter element must be replaced when the indicator shows an alarm and before the Δp reaches the by-pass value setting.

N.B. in cold start conditions a false alarm can be caused by higher oil viscosity due to low temperature; the indicator alarm must be considered at normal working temperature only.

The clogging indicator registers the pressure upstream the filter element:

- with the VISUAL indicator a value higher than 1,3 bar indicates the need of element replacement.
- with the ELECTRIC indicator an electrical switch is activated when the set value 1,3 bar is reached.

VISUAL PRESSURE GAUGE

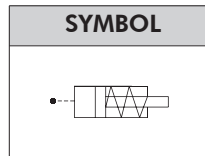
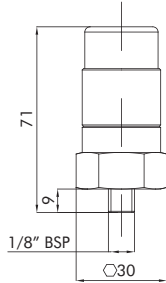

CODE	SETTING
R6	1,3 bar (18,9 psi)

PRESSURE/ VACUUM GAUGE

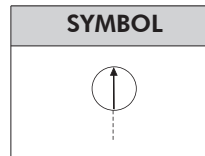
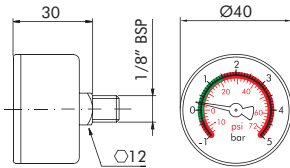

CODE	SCALE
R7	0 ÷ 1,4 bar (0 ÷ 20 psi) green sector
	1,4 ÷ 5 bar (20 ÷ 72,5 psi) red sector

Housing in black ABS material

N.B. Multipurpose product: this gauge can also be used as vacuum gauge on suction filters.

PRESSURE GAUGE

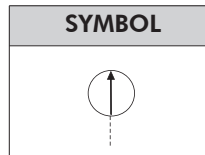
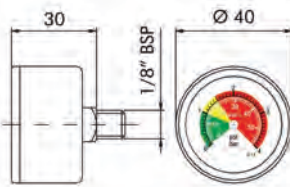

CODE	SETTING
R9	0 ÷ 4 bar (0 ÷ 58 psi)

Housing in black ABS material

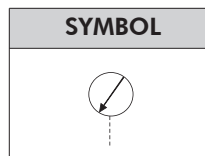
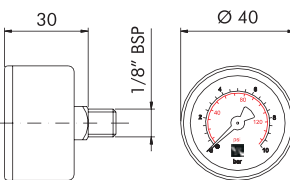

CODE	SETTING
R12	0 ÷ 16 bar (0 ÷ 232psi)

Housing in black ABS material

PRESSURE SWITCH

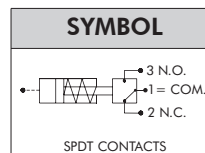
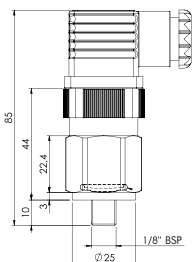

CODE	SETTING
R13	1,3 bar (18,9 psi) SPDT

- DC: 30 V – 4 A inductive, 3 A resistive
- AC: 250 V 3 A inductive, 2 A resistive
- Protection: IP65, connector DIN43650
- SPDT contacts

N.B. it can be used as N.O. contacts or N.C. contacts switch only, simply connecting 1 and 3 or 1 and 2 only, respectively.

Preferential option

Clogging indicator

The Pressure Drop (Δp) through the filter increases during the system operation due to the contaminant retained by the filter element.

The filter element must be replaced when the indicator shows an alarm and before the Δp reaches the by-pass value setting.

N.B. in cold start conditions a false alarm can be caused by higher oil viscosity due to low temperature; the indicator alarm must be considered at normal working temperature only.

The differential clogging indicator registers the pressure upstream and downstream the filter element and activates a signal when the differential pressure reaches the set value:

- in the VISUAL indicator the signal is given by a green sector switching into red.
- in the ELECTRIC VISUAL indicator, further to the green to red visual indication, an electrical switch is activated.

N.B. the set value of the clogging indicator must always be lower than the set value of the by-pass valve.

DIFFERENTIAL VISUAL INDICATOR (for FA-1-3x only)

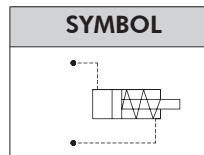
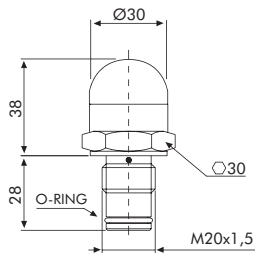

CODE	SETTING
Z1	1,3 bar (18,9 psi)

Visual indicator:

- GREEN: clean element
- RED: dirty element

DIFFERENTIAL ELECTRIC VISUAL INDICATOR (for FA-1-3x only)

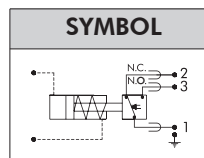
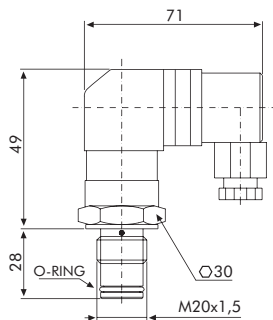

CODE	SETTING
Z2	1,3 bar (18,9 psi)

- Visual indicator:
 - GREEN: clean element
 - RED: dirty element
- Electric plug connection as per DIN 43650
- Protection: IP65 secondo DIN 40050
- Max current: 5A resistive 5A inductive
- Max voltage: 250V AC - 30V DC

DIFFERENTIAL VISUAL SWITCH (for FA-1-4x only)

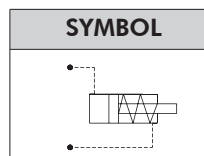
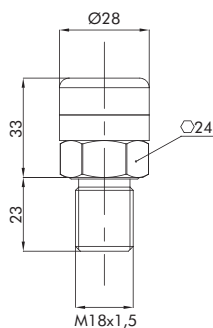

CODE	SETTING
Z20	1,3 bar (18,9psi)

Visual indicator:

- GREEN: clean element
- RED: dirty element

User Tips

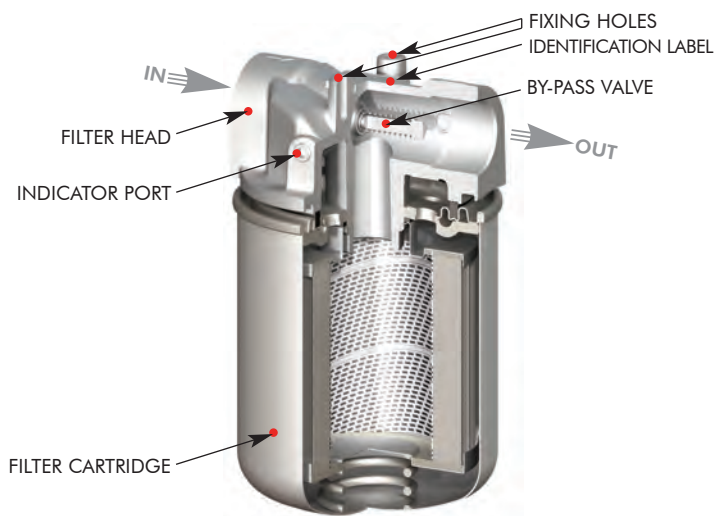

BOWL TIGHTENING TORQUE	
FA-1-xx	3/4 turn

INDICATOR TIGHTENING TORQUE	
R6-R7-R9-R12-R13	30 Nm
S1-S2-S3-S4	
Z1-Z2-Z20	30 Nm

Installation

Make sure that the filter is connected in the correct IN-OUT flow direction (shown by an arrow on the filter head).

The filter housing should be preferably mounted with the bowl downward; the filter head should be properly secured using the threaded fixing holes on the filter head; verify that no tension is present on the filter after mounting.

Make sure that enough space is available for element replacement and that the clogging indicator is in a easily viewable position. If an electrical indicator is used, make sure that it is properly wired.

Never run the system without a filter element fitted. We recommend the stocking of a spare FILTREC filter element for timely replacement when required.

Maintenance

Before unscrewing the cartridge, ensure that the system is switched off and there is no residual pressure in the filter.

Unscrew the cartridge by turning it anticlockwise. Verify the correct part number of the FILTREC replacement cartridge, particularly concerning the micron rating. Ensure that the mounting face is clean, lubricate the gasket of the replacement cartridge prior to assembly. Spin on new cartridge until it reaches the mounting face and tighten for 3/4 turn.

Operation

Make sure that the filter works within the conditions of pressure, temperature and fluid compatibility given in the first page of this data sheet.

The filter element must be replaced as soon as the clogging indicator signals at working temperature (in cold start conditions, oil temperature lower than 30°C, a false alarm can be given due to oil viscosity).

If no clogging indicator is mounted, make sure that the filter element is replaced according to the system manufacturer's recommendations.

PED Compliance

FA-1 filters conform to PED 97/23/CE norm, article 3 section 3, and so they can be used with fluids of group 2 (liquids with steam pressure < 0,5 bar at the maximum allowable temperature, article 3, section 1.1(b) – sub-section II).

WARNING

Make sure that Personal Protective Equipment (PPE) is worn during installation and maintenance operation.

Disposal of filter elements

The used filter elements and the filter parts dirty of oil are classified as "Dangerous waste material": they must be disposed according to the local laws by authorized Companies.



FA-1 series

www.filtrec.com



Technical information may change without notice